

Držák č.1

Montáž: strop
Krycí plechy: ne
Materiál: pozink. ocel

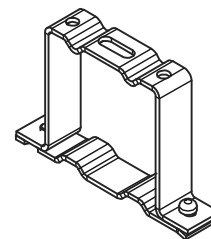
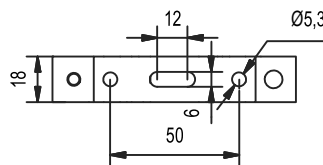
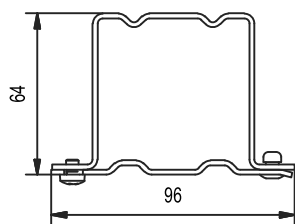

Držák č.1 Al

Montáž: strop
Krycí plechy: ne
Materiál: hliník
Lze kombinovat s držáky č.2,3,4,23,33,13,14,CH (pouze pro hliníkový horní profil)

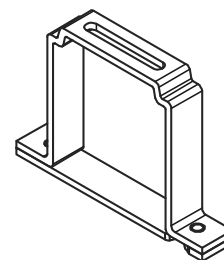
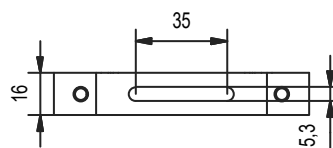
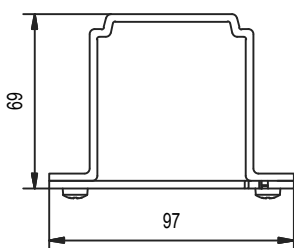

Držák č.R1

Montáž: strop
Krycí plechy: ne
Materiál: pozink. ocel
Lze kombinovat s držáky č.2,3,4,23,33,13,14,CH

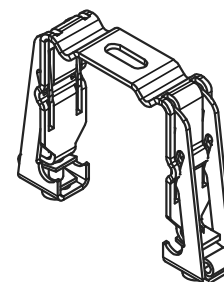
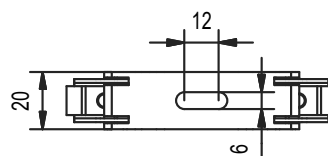
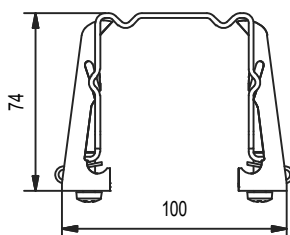

Držák č.2

Montáž: stěna
Krycí plechy: ne
Materiál: pozink. ocel

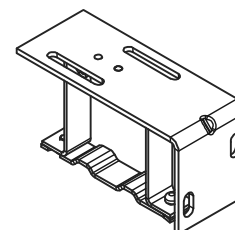
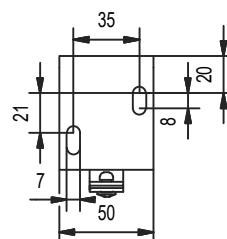
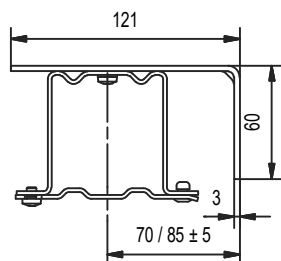

Držák č.3

Montáž: stěna
Krycí plechy: ano
Materiál: pozink. ocel

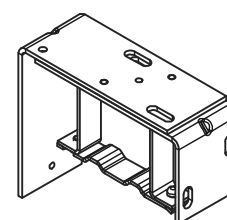
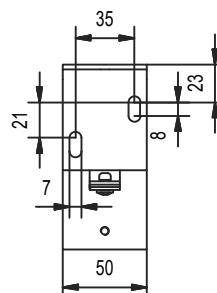
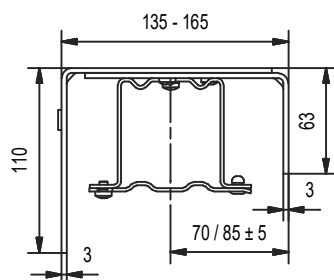

Držák č.4

Montáž: strop
Krycí plechy: ano
Materiál: pozink. ocel

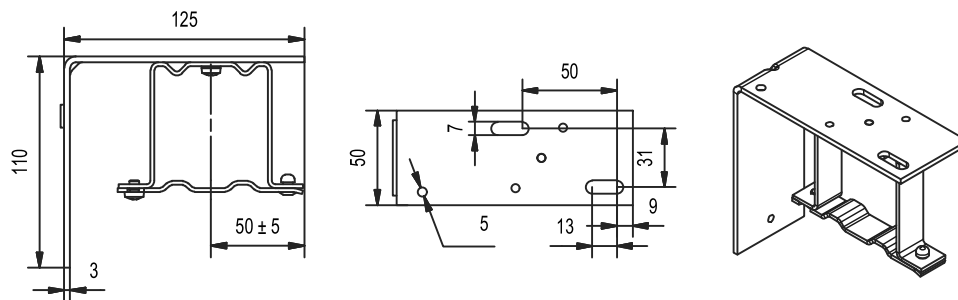
**Držák č.23**

Montáž: stěna
Krycí plechy: ano
Materiál: pozink. ocel

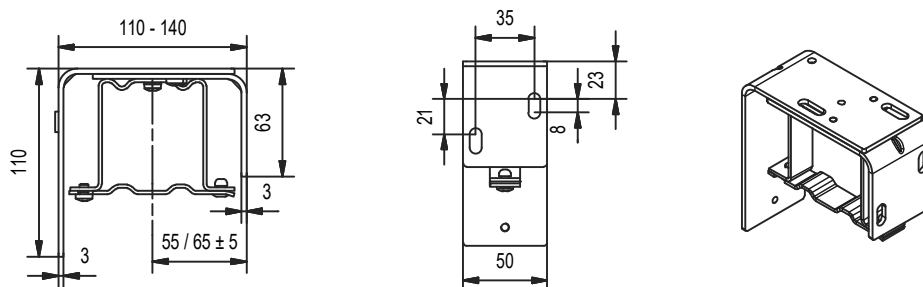
**Držák č.33**

Montáž: stěna
Krycí plechy: ano
Materiál: pozink. ocel

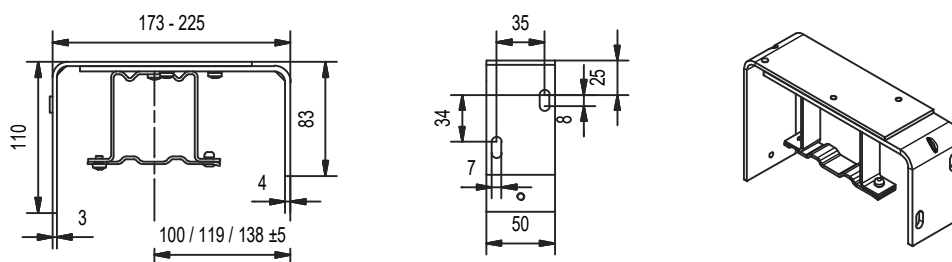
**Držák č.13**

Montáž: stěna
Krycí plechy: pouze 1B,2B,1C,2C
Materiál: pozink. ocel

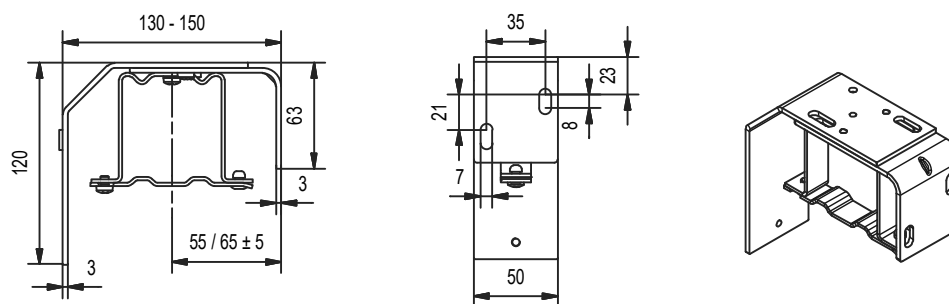
**Držák č.14**

Montáž: strop
Krycí plechy: pouze 1B,2B,1C,2C
Materiál: pozink. ocel

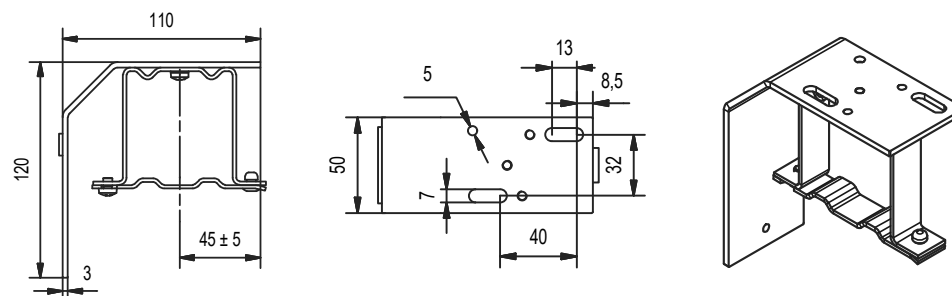

typ S

typ Z

typ C

typ F

typ E

Fasádní
a samonosné
systémyISO-KASTL
a sendvičové
deskyKrycí plechy
a komponentyTechnické
info

Různé

Typy prodloužení pro držáky číslo 3, 4, 23, 33, 13, 14

Pro plechy výšky:

- 140-180 mm - a
- 190-230 mm - b
- 240-280 mm - c
- 290-330 mm - d
- 340-380 mm - e
- 390-430 mm - f
- 440-480 mm - g
- 490-530 mm - h

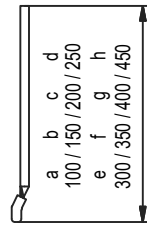
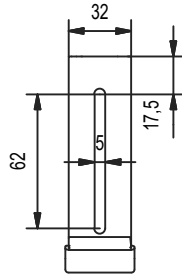

typ S

typ Z

typ C

typ F

typ E

Držák CH2/91

Montáž: stěna
Krycí plechy: ne
Materiál: pozink. ocel

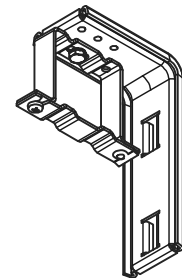
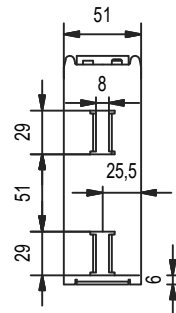
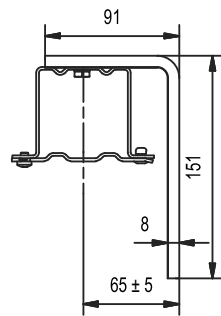

Držák CH2/136

Montáž: stěna
Krycí plechy: ne
Materiál: pozink. ocel

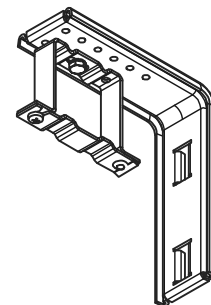
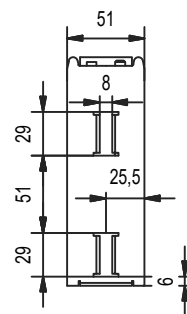
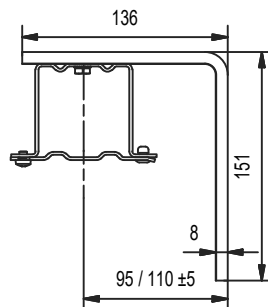

Držák CH3/91

Montáž: stěna
Krycí plechy: pouze pro 1CH12, 1CH14
Materiál: pozink. ocel

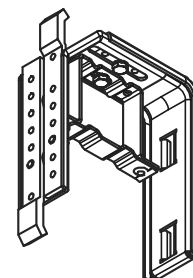
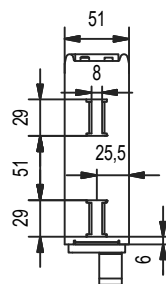
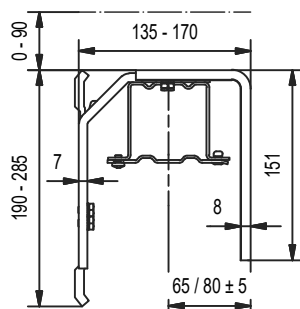

Fasádní a samonosné systémy

ISO-KASTL a sendvičové desky

Krycí plechy a komponenty

Technické info

Různé

Držák CH3/136

Montáž: stěna
 Krycí plechy: pouze pro 1CH12,1CH14
 Materiál: pozink. ocel

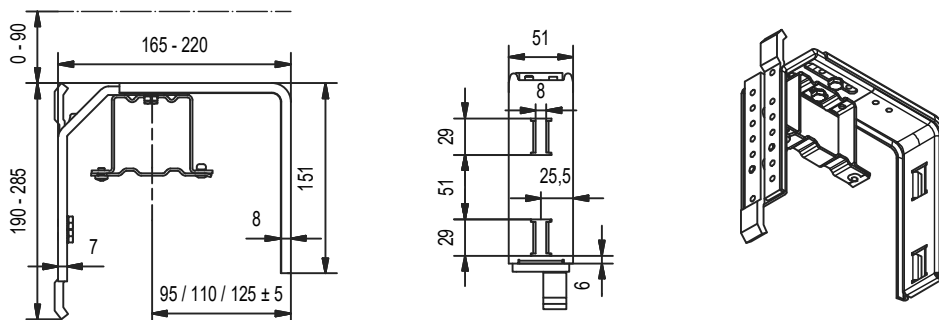

typ S

typ Z

typ C

Typy držáků horního profilu pro žaluzie E-50

Držák č.1-50K

Montáž: strop
 Krycí plechy: ne
 Materiál: hliník

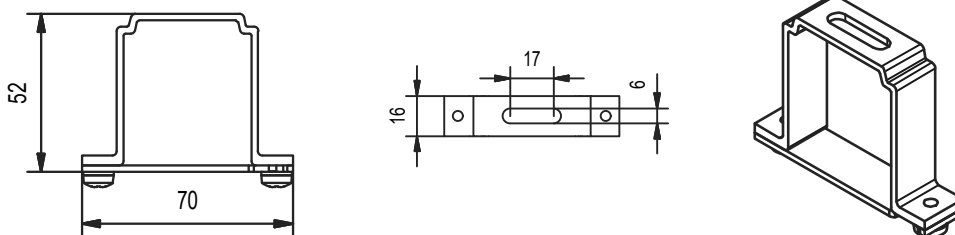

typ F

typ E

Fasádní a samonosné systémy

Držák č.2-50K

Montáž: stěna
 Krycí plechy: ne
 Materiál: hliník

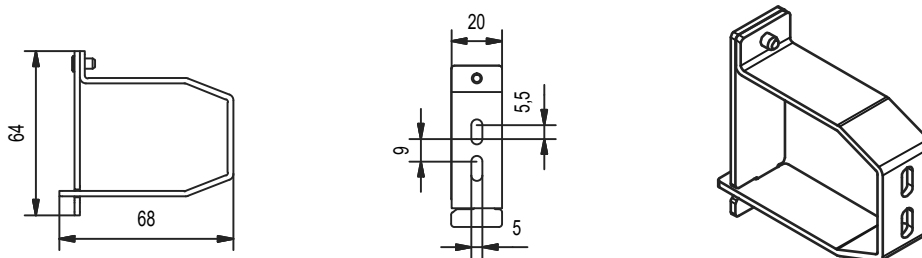

ISO-KASTL a sendvičové desky

Krycí plechy a komponenty

Držák č.3-50K

Montáž: stěna
 Krycí plechy: ano
 Materiál: pozink. ocel+hliník

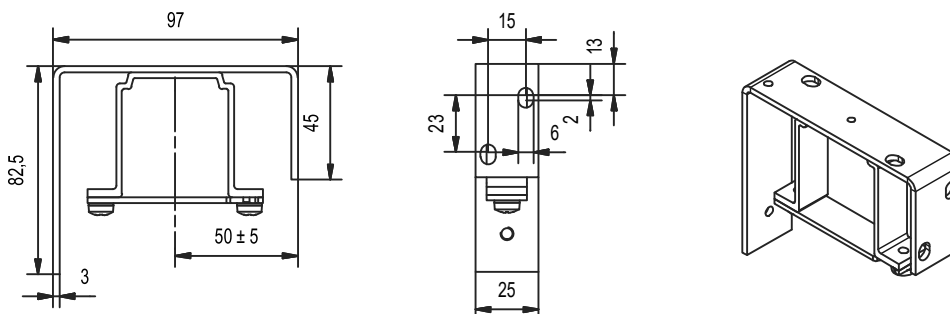

Technické info

Různé