

Meno: _____
 Adresa: _____

 tel.č.: _____
 č.zákazky: _____

Zameriavací list - žalúzie

S90 C80 C65
 Z90 C80S C65S
 Z70 F80 E50

list č. _____

Pohľad: exteriér interiér
 Farba lamiel: _____
 Vodiaci profil: elox RAL: _____
 Spodný profil: elox RAL: _____
 Držiak Hprofilu: _____
 Krycie plechy: áno nie
 Lešenie: áno nie
 Prac.výška lešenia: _____ m
 Montáž: štandard 1. etapa 2. etapa
 Kotvenie: _____
 H.konzola: betón drevo tehla plast
 Držiak VL: _____
 iné: HK: _____
 VL: _____
 Zákazník pripraví kábel: 3-žilový
 4-žilový

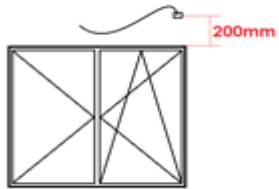

Vedenie (typy vodiacich profilov/lišt)

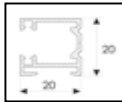

S - štandard
SDV (dvojité)

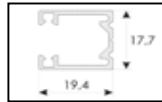

O - ostenie

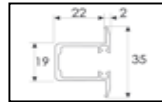

Z - zapustená
XPS - styrodur. doska



K - guľatá VL
KDV (dvojité)

Držiaky VL
A, B, C štandard
TA - TD teleskop.
o ostenie/zapustené

Držiaky Hprofilu

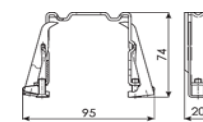

držiak 1R

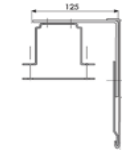

držiak č.4

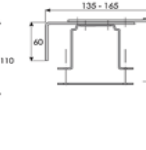

držiak č.3

č.3 - 135-165mm
 č.33 - 173-225mm
 č.23 - 100-140mm

!Všetky rozmery sú v mm!

Poz.	Počet	Stavebný otvor		Žalúzia		Vedenie		Držiak VL	Držiak Hprofilu	Os žalúzie od okna	Dĺžka kľuky	Motorické ovl.		potlač HProfilu (miestnosť)	Poznámka
		šírka	výška	šírka	výška	L'	P					motor	prijímač		
1															
2															
3															
4															
5															
6															
7															
8															
9															
10															
11															
12															
13															
14															

_____ Dátum

_____ podpis zamestnanca

_____ podpis zákazníka



NEVA SK s.r.o.
 Biovetská 7
 949 05 Nitra

Meno: _____
 Adresa: _____
 tel.č.: _____
 č.zákazky: _____

Zameriavací list - krycie plechy

farba: elox RAL: _____
 pohľad: exteriér interiér
 typ: _____

list č. _____

!Všetky rozmery sú v mm!

Poz.	Počet (ks)	Rozmery (mm)			Dĺžka	Boky (ks)		Poznámka
		A	B	C		L'	P	
1								
2								
3								
4								
5								
6								
7								
8								
9								
10								
11								
12								
13								
14								
15								

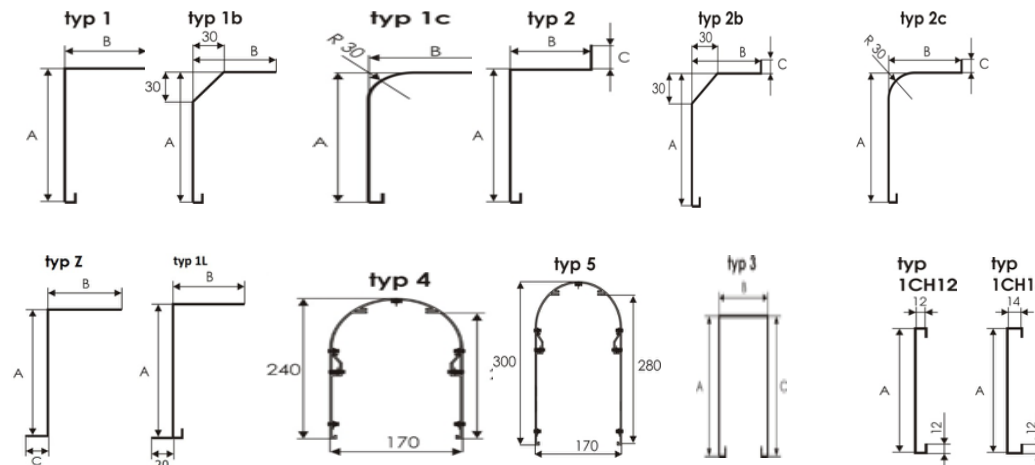

Styrodurové dosky s puzdrami

hrúbka styroduru: _____

Poz.	Počet/ks	dĺžka	šírka	os od okna
1				
2				
3				
4				
5				
6				
7				
8				
9				
10				
11				
12				
13				
14				
15				

Nákres 1

Nákres 2

_____ Dátum

_____ podpis zamestnanca

_____ podpis zákazníka